

Preliminary

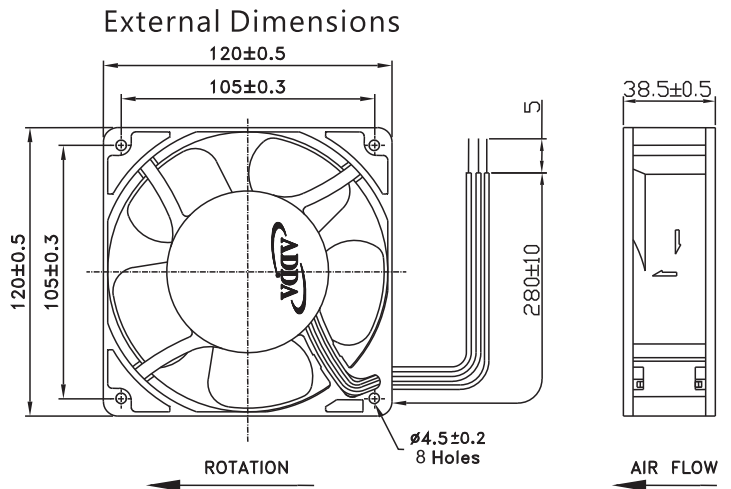

Frame: Plastic(UL:94V-0), Aluminum
 Impeller: Plastic(UL:94V-0)
 Lead wire: UL1007AWG24

Ps. Two different frame materials (Plastic and Aluminum) can be used for AD12038, please note which kind of material you're interested and inform your sales if needed.

Specifications(Nominal)

*:Noise is measured at the distance of one (1) meter from the axis of intake.

Bearing type: ○=Ball ※=Sleeve ◯=1B1S ●=Hypro bearing

Frame size (mm)	Model No.	Bearing System Type	Rated Voltage (VDC)	Current (A)	Power (W)	Rated Speed (rpm)	Maximum AirFlow (CMM)	Maximum AirFlow (CFM)	Maximum Pressure (InAq)	Maximum Pressure (mmAq)	*Noise Level (dB/A)	Weight (g)
120x120x38	AD12012DB385100	◎ ※ ●	12	0.10	1.20	1500	1.621	57.292	0.085	2.159	28.4	235.0 /Plastic
	AD12012LB385100	◎ ※ ●	12	0.17	2.04	1950	2.027	71.635	0.128	3.251	36.2	
	AD12012MB385100	◎ ※ ●	12	0.28	3.36	2540	2.725	96.300	0.228	5.791	45.0	297.0 /Aluminum
	AD12012HB385100	◎ ※ ●	12	0.39	4.68	2800	2.984	105.461	0.265	6.731	46.7	
	AD12012UB385100	◎ ※ ●	12	0.55	6.60	3200	3.399	120.109	0.335	8.509	48.0	

Specifications subject to change without notice.



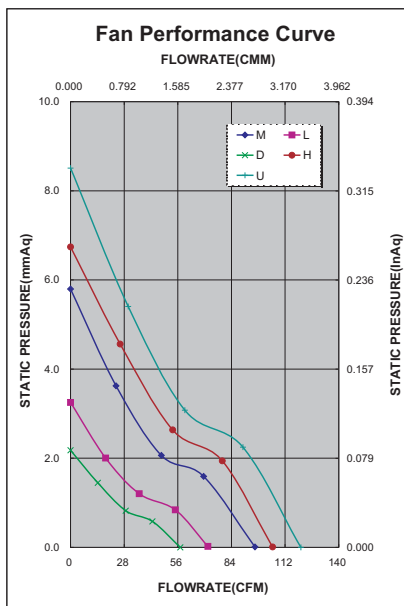

The specification for bearing type is for reference only , for more bearing types information, please contact with your ADDA sales representative, thanks!!
 (網頁上呈現產品軸承資訊均以2Ball為主, 若需其他產品資訊請聯絡您在ADDA的業務代表, 謝謝!!)



*Motor protective circuit and third lead wire functions

0	1	2	3	4	6	7	8	9	A	B
✓	✓	✓	✓	✓	✓					

*Safety approvals

				
				✓